





# QUICK REFERENCE SHEET

This is a list of pages that relate to specific types of equipment. You can use this to help you get up and running quickly if you don't have time to follow through the whole manual.

**Standard PTZ camera kit:** pages 2, 5, 6, 15-18, 21-26, 32

**Fixed camera kit :** all pages listed above plus pages 3, 19

**DVR:** pages 3, 7, 8, 28, 29, 30

**Dual transmitter:** pages 17, 18, 19

**LCD controller:** pages 4, 6, 13, 25, 26, 27

**Outdoor antennas:** pages 4, 14, 20

**Outdoor receivers:** pages 4, 9, 10, 11, 12, 31

## HELPFUL DIAGRAMS :

**In house assembly diagram:** page 5

**Standard setup diagram:** page 6

**DVR setup diagram with 4 receivers/rear view of DVR :** page 8

**Outdoor receiver setup diagram:** page 11

**Outdoor receiver with DVR setup diagram:** page 12

**LCD controller setup diagram:** page 13

**Receiver with panel antenna:** page 14

**Setup diagram with PTZ camera:** page 18

**Setup diagram with fixed camera:** page 19

**Dual transmitter setup:** page 19

**Audio mod setup:** page 20

**Transmitter with panel antenna:** page 20

**Receiver layout diagram:** page 21

**Remote layout diagram:** page 22

**Controller layout diagram:** page 25

**LCD controller layout diagram:** page 27

**DVR layout diagram:** page 28

**Transmitter channel button location:** page 31

**Audio mod volume knob location:** page 31

# TABLE OF CONTENTS

◆ Information for new customers.....	1
◆ What comes with the PTZ camera kit.....	2
◆ What comes with the fixed camera kit.....	3
◆ What comes with the DVR kit.....	3
◆ What comes with the outdoor receiver kit.....	4
◆ Other accessories.....	4
◆ Quick setup guide for in-house testing.....	5
◆ Setting up at the house: Standard setup.....	6
◆ Setting up at the house: DVR setup (smart phone option).....	7, 8
◆ Setting up at the house: Outdoor receiver setup.....	9, 10, 11
◆ Setting up at the house: Outdoor receiver setup with DVR.....	12
◆ Setting up at the house: LCD controller setup.....	13
◆ Setting up at the house: High gain panel antenna setup.....	14
◆ Setting up at the barn: Mounting the Camera.....	15, 16
◆ Setting up at the barn: Mounting the Transmitter.....	17, 18, 19
◆ Setting up at the barn: Dual transmitter setup.....	19
◆ Setting up at the barn: Audio mod setup.....	20
◆ Setting up at the barn: High gain panel antenna.....	20
◆ Using your system: The receiver.....	21
◆ Using your system: The receiver remote.....	22
◆ Using your system: Advanced receiver functions.....	23, 24
◆ Using your system: The PTZ joystick controller.....	25, 26

# TABLE OF CONTENTS

◆ Using your system: The LCD controller.....	27
◆ Using your system: The DVR.....	28, 29, 30
◆ Using your system: The outdoor receiver.....	31
◆ How to change the transmitter channel.....	31
◆ How to adjust the audio mod.....	31
◆ PTZ camera features.....	32
◆ Troubleshooting: Static or poor picture.....	33, 34
◆ Troubleshooting: No PTZ control.....	34
◆ Troubleshooting : Camera is “dead spinning”.....	35
◆ Troubleshooting: Other common problems and solutions.....	35
◆ Troubleshooting flow chart: No PTZ control.....	36
◆ Troubleshooting flow chart: No picture.....	37
◆ Troubleshooting flow chart: Poor picture.....	38
◆ Warranty information.....	39
◆ Loaner program.....	40
◆ System notes.....	41

## ATTENTION NEW CUSTOMERS

Thank you for purchasing your new Livestock Monitoring System! You are sure to get many years of use from your new wireless video system. It comes with a one-year warranty on parts and labour, and we fully assemble and test your system before it leaves our shop to ensure it's in fully working condition when it arrives at your door.

We do strongly recommend you watch our DVD manual and fully assemble your system in your house before proceeding with the final installation. This will ensure you have a full understanding of how the system works, and will also allow you to verify everything works and nothing was lost or damaged in transit.

Should you have any trouble please refer to our online troubleshooting guides and videos on our website [cowcam.ca](http://cowcam.ca), or the troubleshooting chart at the back of this manual.

If you need further assistance feel free to call us at 1-866-289-8164 or 1-204-728-8878 between the hours of 8:30AM to 5:00PM (central time) Monday to Friday.

If you are within Manitoba or Saskatchewan, please do not forget to send one copy of your invoice back to us with your section/township/range and signature for Cow Cam to be PST exempt!

**Thank You! And Enjoy!**

Like us on Facebook /AllenLeighSC  
Follow us on Twitter @AllenLeighSC  
Check out all our products at [www.allenleigh.ca](http://www.allenleigh.ca)



A Brand of



# WHAT COMES WITH THE PTZ CAMERA KIT



- A) PTZ Camera,
- B) camera mount with mounting hardware,
- C) transmitter with antennas, mounting bracket, and mounting hardware,
- D) 30' Camera power cable (red cable with orange ends),
- E) 30' Transmitter power cable (red cable with black ends),
- F) camera cable (black cable with round ends),
- G) camera power supply with mounting hardware,
- H) transmitter power supply with mounting hardware,
- I) PTZ joystick controller with power supply and antenna (excluded from add-on kit) *your unit may come with a smaller antenna then shown,*
- J) receiver with power supply, 12' RCA cable, antenna, and remote (excluded from add-on kit).

## WHAT COMES WITH THE FIXED CAMERA KIT

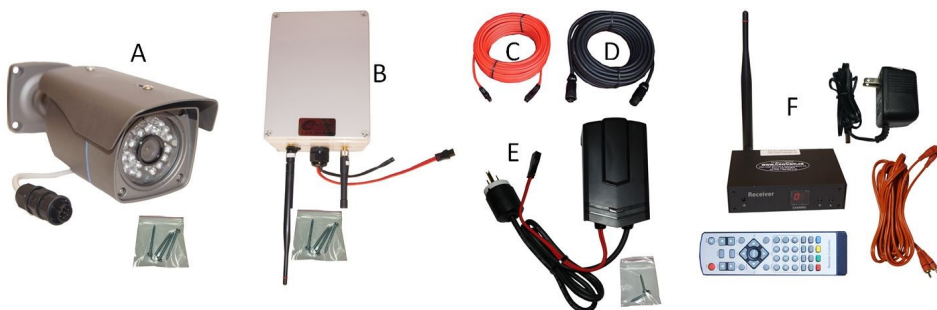

- A) Fixed camera with mounting hardware,
- B) transmitter with antennas, mounting bracket, and mounting hardware,
- C) 30' Transmitter power cable (red cable with black ends),
- D) camera cable (black cable with round ends),
- E) transmitter power supply with mounting hardware,
- F) receiver with power supply, 12' RCA cable, antenna, and remote (excluded from add-on kit).

## WHAT COMES WITH THE DVR KIT

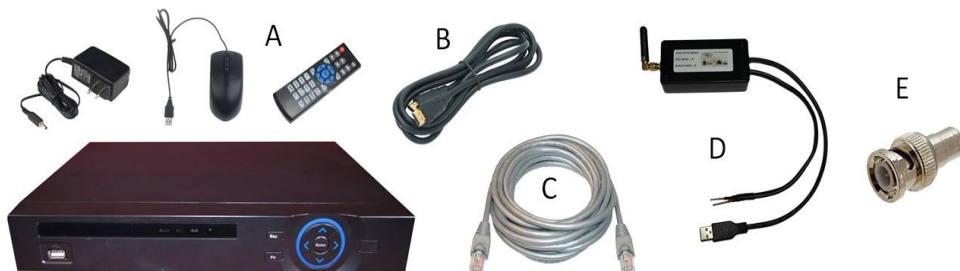

- A) Digital Video Recorder (DVR) with power supply, mouse, and remote,
- B) 6' HDMI cable,
- C) Cat5 network cable (standard length is 30'),
- D) data box,
- E) BNC to RCA adapter (kit comes with one for each receiver being used).



# WHAT COMES WITH THE OUTDOOR RECEIVER KIT

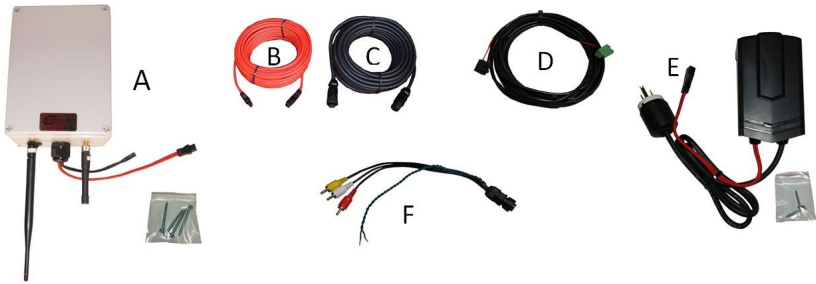

- A) Outdoor receiver with antennas, mounting bracket, and mounting hardware,
- B) 30' receiver power cable (red cable with black ends),
- C) video cable (black cable with round ends),
- D) cable to connect controller to outdoor receiver adapter with terminal block (black cable with red and Black wires inside ) usually about 12' long,
- E) receiver power supply with mounting hardware,
- F) outdoor receiver video and data adapter/splitter.

## OTHER ACCESSORIES



- A) PTZ joystick controller with built in LCD monitor,
- B) high gain panel antenna for transmitter or receiver,
- C) audio mod,
- D) high gain YAGI antenna for PTZ controller or data box,
- E) SMA antenna adapter,
- F) extra long RCA cable for receiver (comes in 25,50, or 100 foot),
- G) RCA splitter cable,
- H) RCA coupler.

# QUICK SETUP GUIDE FOR IN-HOUSE TESTING

We do strongly recommend you watch our DVD manual and fully assemble your system in your house before proceeding with the final installation. This will ensure you have a full understanding of how the system works, and will also allow you to verify everything works and nothing was lost or damaged in transit.

Below is a quick reference diagram to aid you in assembling the system to test it in the house. If you get stuck you can skip forward to the full installation instructions for help.

This diagram includes the most common type of setup, there will be full installation instructions later in the manual for all types of equipment.

## In house assembly diagram:

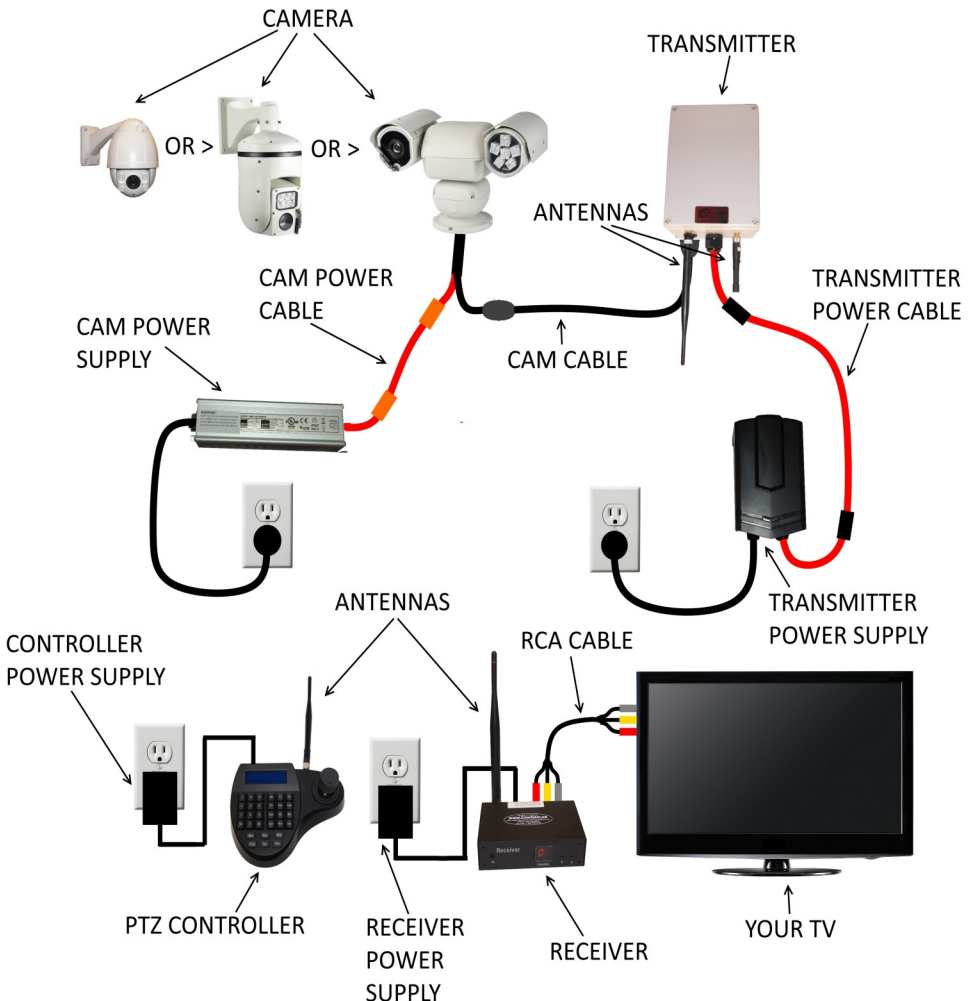

# SETTING UP AT THE HOUSE: STANDARD SETUP

## If you have a DVR start at the next page

Once you have finished setting up and testing everything in the house its time to get things up and running.

We will start at the house. First get your receiver, power supply, antenna, and RCA cable.

- Twist the antenna marked “for receiver” on to the gold antenna connector on the back of the receiver unit and point it up.
- Next, connect one end of the RCA video cable to the audio and video out connectors on the back of the receiver. Normally you can match the colors of the connectors, but if your cable does not have a yellow plug, you will have to use another one of the connectors in its place such as black.
- Now, connect the other end of the RCA cable to your TVS video input. This is sometimes called video1, AV1, or composite. Some TVS do not have a dedicated yellow video plug , in this case you will need to use the green connector.
- Connect the power supply to the power input on the back of the receiver unit and plug it in to a wall power connection.
- Place the receiver on a high surface with the antenna pointing up, facing the wall that faces the barn or camera location.

*(see page 33 for more tips on best receiver placement)*

Now we will setup your controller. You will need the PTZ joystick controller, power supply, and antenna.

- Twist the antenna marked “for controller” onto the antenna connector on the back of the controller, and point the antenna up.
- Next, connect the power supply to the power in port on the back of the controller and plug it in to a wall power connection.
- Place the controller on a stable surface where it will not be exposed to high levels of static electricity.

### Standard setup diagram:

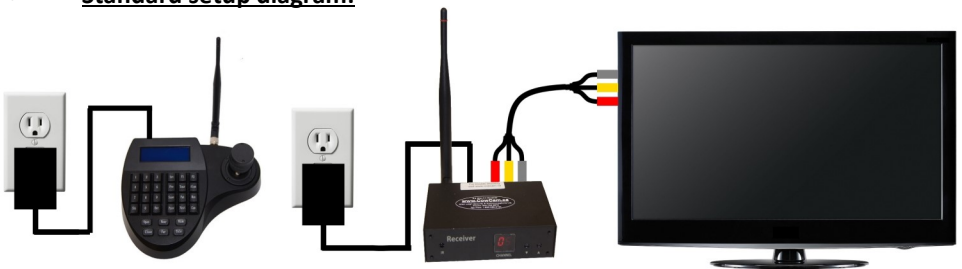

# **SETTING UP AT THE HOUSE: DVR SETUP**

## **(SMART PHONE OPTION)**

The DVR or Digital Video Recorder (AKA the smart phone option) allows you record with your CowCam, and also connects your cameras to the internet so you can view them remotely from a cellphone or tablet.

To set up your DVR you will need your DVR, power supply, HDMI cable, Data box, cat5 network cable and mouse.

- Connect the HDMI cable to the HDMI port on the back of the DVR, then connect the other end of the cable to one of your TV's HDMI inputs (make note of what input you use).
- Next, connect one end of the cat5 network cable to the LAN port on the back of the DVR, connect the other end of the cable to an unused LAN port on your internet router.
- Connect the USB cable of the data box to the USB port on the back of the DVR (USB cable is for power only), and connect the red and black wires to the A/B ports on the back of the DVR red=A black=B.
- Connect the mouse to the USB port on the front of the DVR.
- Connect the power supply to the power input jack on the back of the DVR and plug it into a wall connection.

Next we will get the receiver or receivers connected to the DVR. You will need your receivers, power supplies, RCA cables, antennas, and BNC to RCA adapters.

- Twist the antenna marked "for receiver" on to the gold antenna connector on the back of the receiver unit and point it up.
- Next, connect one end of the RCA cable to the audio and video out connectors on the back of the receiver. Normally you can match the colors of the connectors, but if your cable does not have a yellow plug, you will have to use another one of the connectors in its place such as black.
- Now, connect the other end of the RCA cable to the input of the DVR using the BNC to RCA adapters. In most cases audio is unused for DVR applications so you can leave the red and white audio cables disconnected. If you have more than one receiver, connect them all to the DVR in order from CH 1 to CH4 only connecting the yellow video cables.
- Connect the power supply to the power input on the back of the receiver unit and plug it in to a wall power connection.
- Place the receiver on a high surface with the antenna pointing up and facing the wall that faces the barn or camera location.

*(see page 33 for more tips on best receiver placement)*

# SETTING UP AT THE HOUSE: DVR SETUP (SMART PHONE OPTION)

DVR setup diagram with 4 receivers:

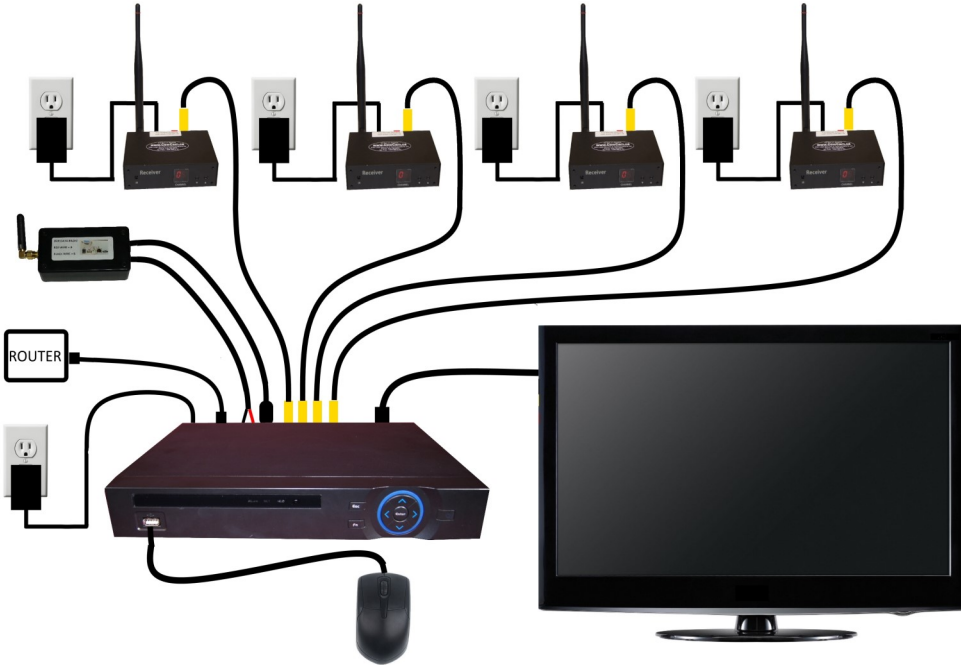

Rear view of DVR:

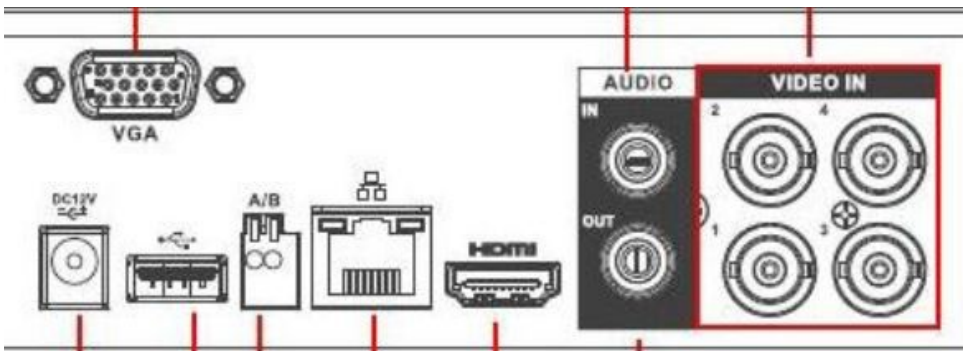

*(To see how to set up the DVR to work on your smartphone go to page 30)*

# SETTING UP AT THE HOUSE: OUTDOOR RECEIVER

## SETUP

If you require an outdoor receiver there are some special set up instructions:

- The outdoor receiver kit allows you to move the receiver to the outside of the house to achieve a better line of sight and batter signal.
- The outdoor receiver also contains a data transmitter for your PTZ controller to allow for a better line of sight for the control signal as well.
- The outdoor receiver must be mounted outside your house facing toward your barn or camera location.
- You will need to have a power connection within 30' of the receiver mounting location.
- We don't recommend mounting it directly below the eaves trough or roof line as this will expose the receiver to more water and ice which may hinder its performance.

To set up your outdoor receiver you will need the outdoor receiver, receiver power supply, video cable, receiver power cable, outdoor receiver adapter, PTZ joystick controller, controller cable, controller power supply, mounting bracket, and mounting hardware.

- First, line up the mounting bracket where you want to mount the receiver. Mark and drill 4 holes, then secure the bracket with the included mounting screws.

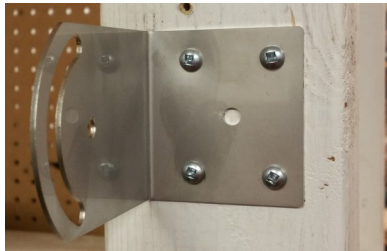

- Next, screw the antennas onto the antenna connectors on the bottom of the transmitter, paying attention to the labels on the antennas and receiver to make sure they are in the correct position.

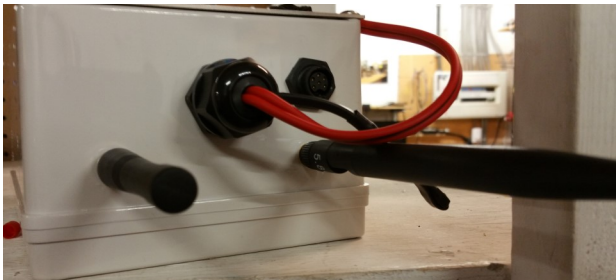

# SETTING UP AT THE HOUSE: OUTDOOR RECEIVER

## SETUP

- Now, using the included nuts, bolts, and washers, attach the receiver to the mounting bracket, making sure the antennas and connectors are facing down.

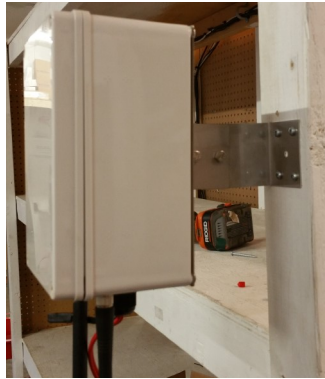

- Connect the video cable to the matching port on the bottom of the outdoor receiver.
- Run the video cable into the house to your TV location from where you wish to view the camera.
- Connect the receiver power cable to the matching connector on the outdoor receiver, and run the cable towards the power connection.
- Mount the receiver power supply near the power outlet using the supplied mounting screws and connect the transmitter power cable to it. Do not plug in the power supply yet.



# SETTING UP AT THE HOUSE: OUTDOOR RECEIVER

## SETUP

- Connect the outdoor receiver adapter to the camera cable and plug the RCA cables to your TVs video input. This is sometimes called video1, AV1, or composite. Some TVs do not have a dedicated yellow video plug, in this case you will need to use the green connector (see next section for instructions for use with DVR).
- Now, connect the controller cable to outdoor receiver adapter using the supplied terminal block . Red wire to green wire, black wire to blue wire.
- Connect the other end of the controller cable to the back of the joystick controller using the green 5 pin terminal block that came with the controller. Red wire goes to A+, black wire goes to B-.
- Next, connect the power supply to the power in port on the back of the controller and plug it in to a wall power connection.
- Place the controller on a stable surface where it will not be exposed to high levels of static electricity.
- Now plug in the receiver power supply.

### Outdoor receiver setup diagram:

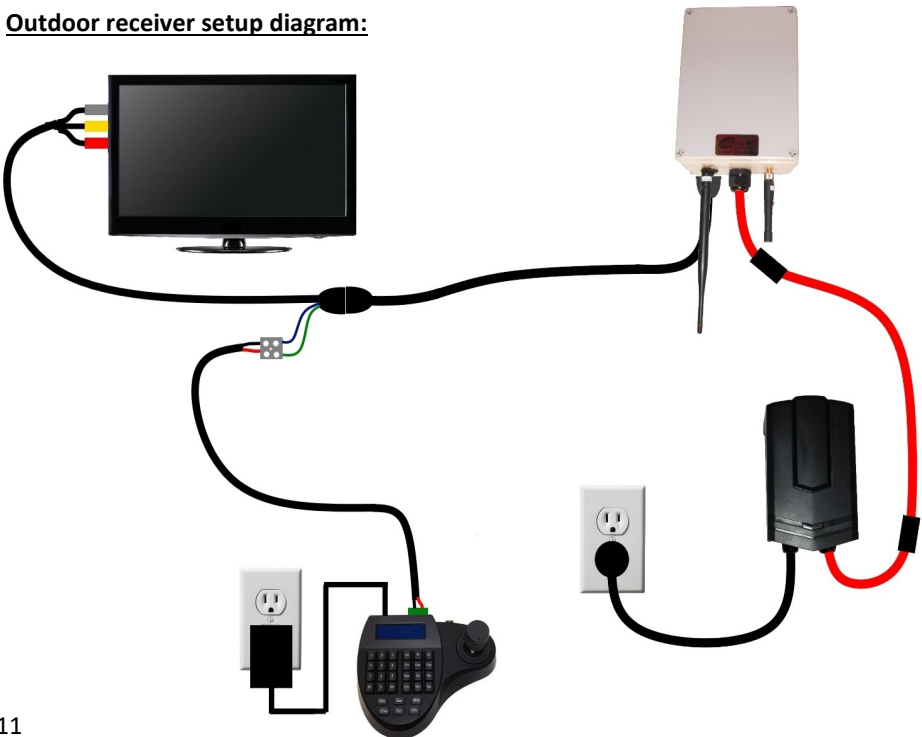



# SETTING UP AT THE HOUSE: OUTDOOR RECEIVER

## SETUP WITH A DVR

Setting up an outdoor receiver to be used with a DVR is the same as setting it up to be used with a TV and joystick controller, except instead of connecting the RCA cables to the TV, you will connect them to the video input of the DVR, and instead of connecting the controller cable to the PTZ joystick controller, you will connect it to the A/B ports on the DVR.

- You will not need to use a data box for this type of setup.
- When connecting the controller cable to the back of the DVR, the red wire goes to the A port, and the black wire goes to the B port.
- If you are using the outdoor receiver with more than one camera, you will need to use RCA splitters to feed the video signal into all the video inputs of the DVR.
- Please see the DVR setup section for detail instructions on setting up your DVR (pages 28-30).

### Outdoor receiver with DVR setup diagram:

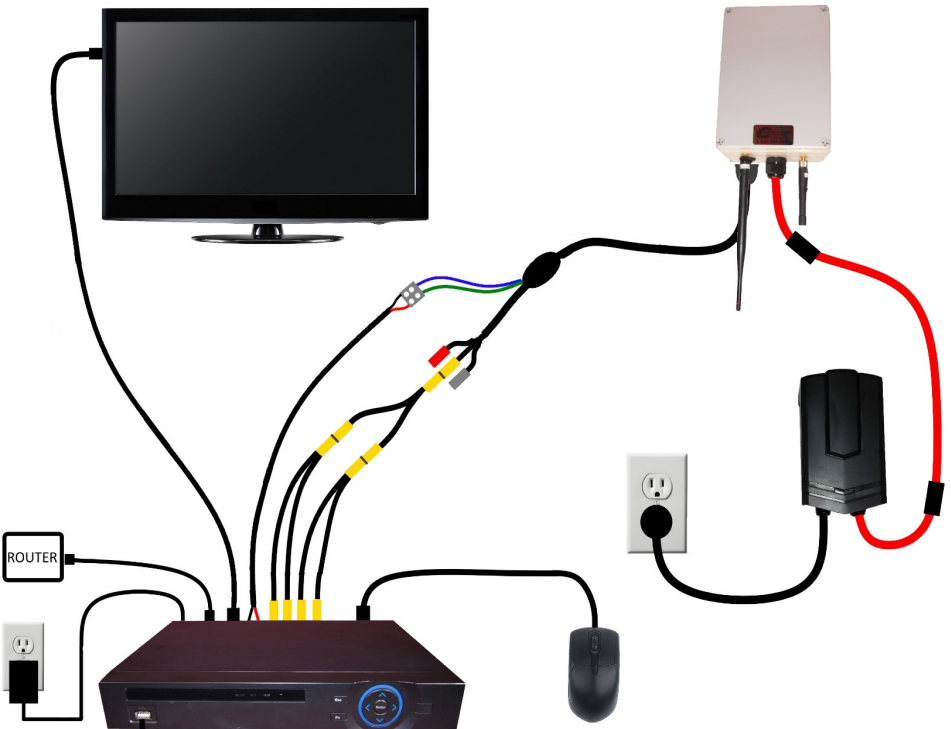

# SETTING UP AT THE HOUSE: LCD CONTROLLER SETUP

To set up the PTZ joystick controller with built in LCD monitor, you will need the LCD controller, controller power supply, controller antenna, receiver, RCA cable, receiver power supply, receiver antenna, and BNC to RCA adapter.

- Twist the antenna marked “for controller” onto the antenna connector on the back of the controller, and point the antenna up.
- Next, connect the power supply to the power in port on the back of the controller and plug it in to a wall power connection.
- Place the controller on a stable surface where it will not be exposed to high levels of static electricity.
- Twist the antenna marked “for receiver” on to the gold antenna connector on the back of the receiver unit and point it up.
- Next, connect one end of the RCA video cable to the audio and video out connectors on the back of the receiver. Normally you can match the colors of the connectors, but if your cable does not have a yellow plug, you will have to use another one of the connectors in its place such as black.
- Now, connect the other end of the RCA cable to the controllers video input connector using the BNC to RCA adapter. Please note the LCD controller does not support audio, so you will not need to connect the red or white audio cables to it.
- Connect the power supply to the power input on the back of the receiver unit and plug it in to a wall power outlet.
- Place the receiver on a high surface with the antenna facing the wall that faces the barn or camera location (*see page 33 for more tips on receiver placement*).

## LCD controller setup diagram:



# SETTING UP AT THE HOUSE: HIGH GAIN PANEL

## ANTENNA SETUP

To set up the high gain panel antenna you will need the panel antenna, mounting bracket, antenna cable, and mounting hardware.

- Start by attaching the mounting bracket to the back of the panel antenna using the supplied mounting hardware, and connect the antenna cable.

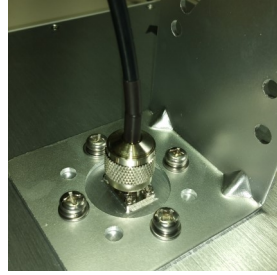

- Now, mount the antenna with the curved side facing toward the transmitter at the barn. You can mount it using 2 standard wood screws, or with the supplied pole mounting kit. Pay attention to the direction of the H and V arrows to ensure the correct orientation of the antenna. The V arrow should point up, and the H arrow should point to the right. You may need tweak the orientation of the antenna to get the best signal.



- Then run the antenna cable into your house and connect it to the antenna connector on the back of your receiver. If you already have an antenna on the receiver it will need to be removed before connecting the cable (*max recommended cable length is 20'*).

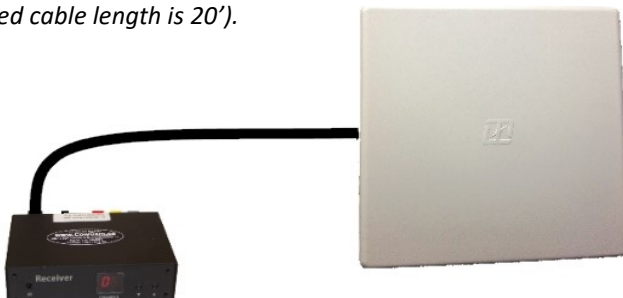

# **SETTING UP AT THE BARN: MOUNTING THE CAMERA**

The first step to setting up at the barn is mounting the camera. You will need your camera, camera power supply, camera power cable, camera cable, mounting hardware, and your mount. If you have a fixed camera, you will not need the mount, camera power cable, or camera power supply.

- It is ok to mount the camera outside as it is completely weather proof, however we don't recommend mounting it directly below the eaves trough or roof line as this will expose the camera to more water and ice which may hinder its performance.
- You will need to have a power connection within 30 feet of the camera mounting location. If you have a fixed you do not have to worry about this as the camera is powered through the camera cable.
- Before starting the installation, make sure you will be able secure the camera mount directly to a stud or into a solid pole. If this is not possible, we recommend reinforcing with 3/4" plywood or better.

Your mounting kit includes: 1 camera mount, 4 track bolts, 4 washers, 4 lock nuts, and 4 lag bolts.

- The first thing you need to do is set the 4 track bolts in the mount to create studs for the camera. To do this, put the bolt through the correct hole, then on the opposite side, stack up the 4 washers on the bolt with the nut on top, then tighten the nut until the track bolt pulls itself into the hole. You can also use a hammer to set the bolts in place if you wish.
- To determine what holes to put the track bolts in, put the camera over the mount and observe which holes line up with the mounting plate of the camera.



- Now, place the mount where you wish to install the camera, mark out and drill the 4 mounting holes with the appropriate sized drill bit, and fasten the mount with the 4 included lag bolts.

# SETTING UP AT THE BARN: MOUNTING THE CAMERA

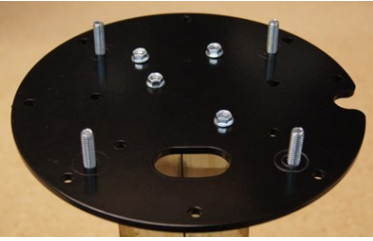

OR >



- Finally, feed the cameras cable through the mount, slide the camera onto the track bolt studs, and secure it with the included lock nuts.



OR >



- It is recommended that you electrically ground the camera mount whenever possible. This will help to protect the camera in the event of lightning or static discharge.
- You can also install the camera without using the mount by using the lag bolts and the cameras existing mounting holes if you prefer.
- Now, connect the camera cable and camera power cable to the matching connectors on the camera pigtail.
- Run the camera cable to the location you plan to mount the transmitter.
- Run the camera power cable towards the power connection.
- Mount the camera power supply near the power connection using the supplied mounting hardware and connect the camera power cable. Do not plug in the camera power supply yet.



# SETTING UP AT THE BARN: MOUNTING THE TRANSMITTER

Now that you have the camera set up, we can get the transmitter set up. The transmitter is what sends the camera signals to the house.

- The transmitter should always be mounted outside facing the house, with the antennas pointing down.
- You should mount the transmitter as high up as possible while still being able to access it if needed for servicing.
- The transmitter will need to be mounted within 30' of a power connection.
- We don't recommend mounting it directly below the eaves trough or roof line as this will expose the transmitter to more water and ice which may hinder its performance .

To mount the transmitter you will need the transmitter, transmitter power supply, transmitter power cable, antennas, mounting bracket, and mounting hardware.

- First, line up the mounting bracket where you want to mount the transmitter, mark and drill 4 holes, then secure the bracket with the included mounting screws.

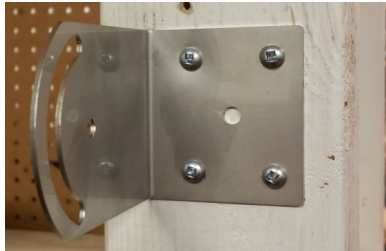

- Next, screw the antennas onto the antenna connectors on the bottom of the transmitter, paying attention to the labels on the antennas and transmitter to make sure they are in the correct position.

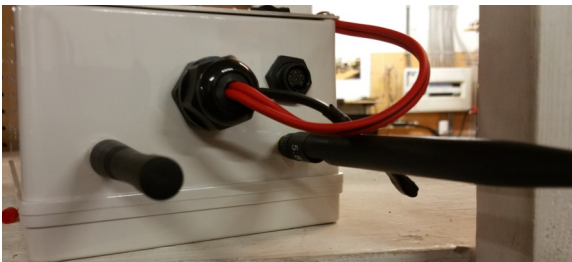

# SETTING UP AT THE BARN: MOUNTING THE TRANSMITTER

- Now, using the included nuts, bolts, and washers, attach the transmitter to the mounting bracket, making sure the antennas and connectors are facing down.



- Connect the camera cable to the matching port on the bottom of the transmitter.
- Connect the transmitter power cable to the matching connector on the transmitter, and run the cable towards the power connection.
- Mount the transmitter power supply near the power connection using the supplied mounting screws and connect the transmitter power cable to it.
- Now, plug in both the transmitter power supply and the camera power supply.
- Watch the camera to see if it starts moving once you plug it in. If it moves you have successfully installed it and the camera is now ready to use!

**Setup diagram with PTZ camera.** See next page for fixed camera diagram

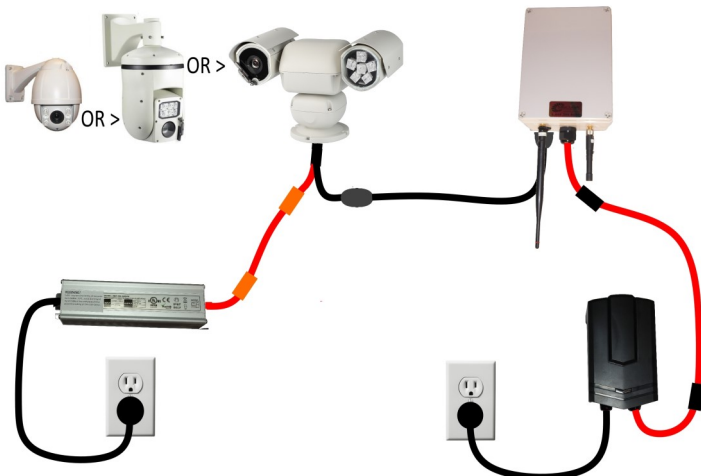

# SETTING UP AT THE BARN: MOUNTING THE TRANSMITTER

## Setup diagram with fixed camera



# SETTING UP AT THE BARN: DUAL TRANSMITTER SETUP

The process to set up a dual transmitter is the same as setting up a normal transmitter, the only difference is you will be connecting 2 cameras to it instead of just one.

- Dual transmitters also require a different power supply box than the standard transmitter. This is supplied with the unit.

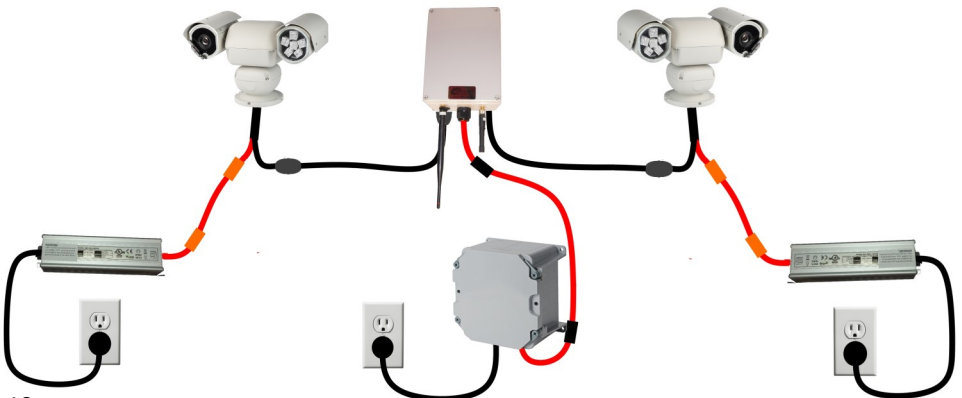



## SETTING UP AT THE BARN: AUDIO MOD SETUP

The audio mod box adds sound to your cowcam system. To install the audio mod, disconnect the camera cable from the camera and connect it to one side of the audio mod box, then connect the camera to the other side of the audio mod box.

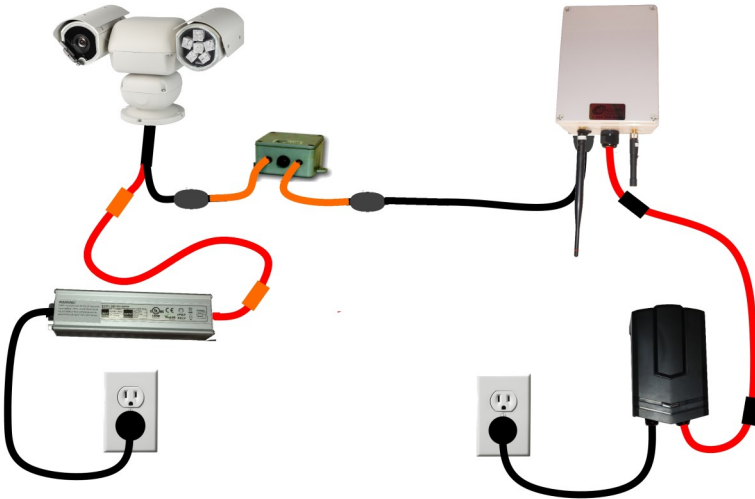

## SETTING UP AT THE BARN: HIGH GAIN PANEL ANTENNA SETUP

Setting up the high gain panel antenna at the barn is the same process as setting it up at the house. The only difference is you plug the antenna cable into the 5.8ghz antenna port of the transmitter instead of the receiver. Please see the previous section on panel antenna setup for full installation instructions (*page 14*). Have the antenna facing the receiver at the house.

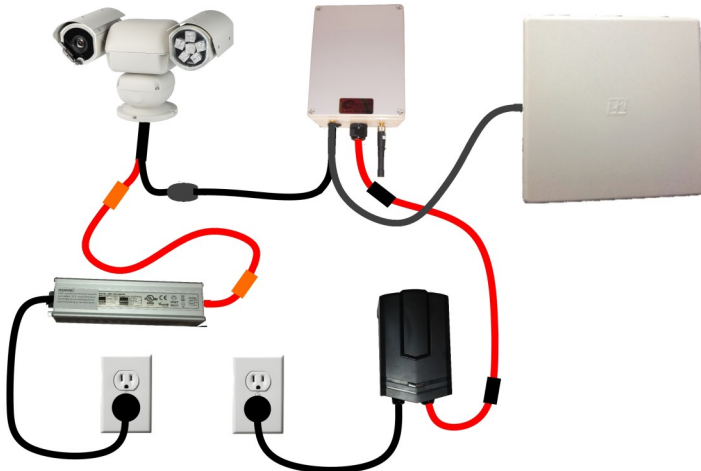

## USING YOUR SYSTEM: THE RECEIVER

The receiver is what picks up the video signal from the transmitter at the barn.

There are 2 ways you can control your receiver:

- You can use the up and down buttons on the front of the receiver to change the channel,
- or you can use the included remote to change the channel, add and delete channels, or configure the auto circulate function.

### Receiver layout diagram:

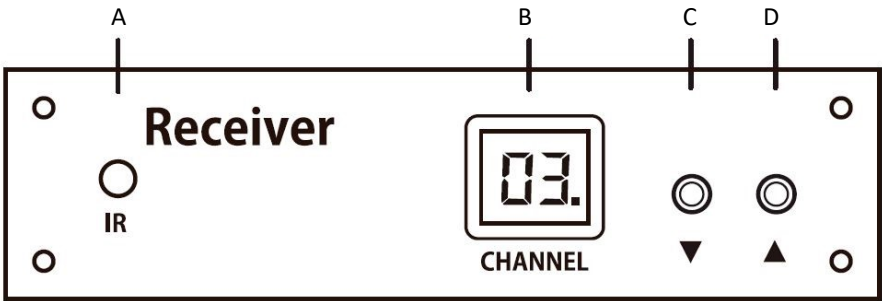

- A) IR remote control receiver,
- B) channel display,
- C) channel down button,
- D) channel up button.

When you first setup your receiver, it should be set to CH1 by default. This is also the channel that your camera will most likely be set to. If you have more than one camera, you can determine what channel each camera is on by looking at the sticker on the bottom of the transmitter for that camera.

Once you have receiver set to the correct channel, you will need to make sure your TV is set to the correct input. You can usually find what input you are using by looking for a label near the input connector on the TV. If you are unsure of how to change the input please refer to your TV's operating manual.

To switch which camera you are viewing, simply switch the channel using the channel buttons on the receiver or the remote.

You may notice that there is a flashing dot after the channel number on the receiver's display. Don't worry about this dot, it doesn't have anything to do with the receiver's operation.

# USING YOUR SYSTEM: THE RECEIVER REMOTE

In addition to the buttons on the front of the receiver, you can use the IR remote to switch between channels.

## Remote layout diagram:

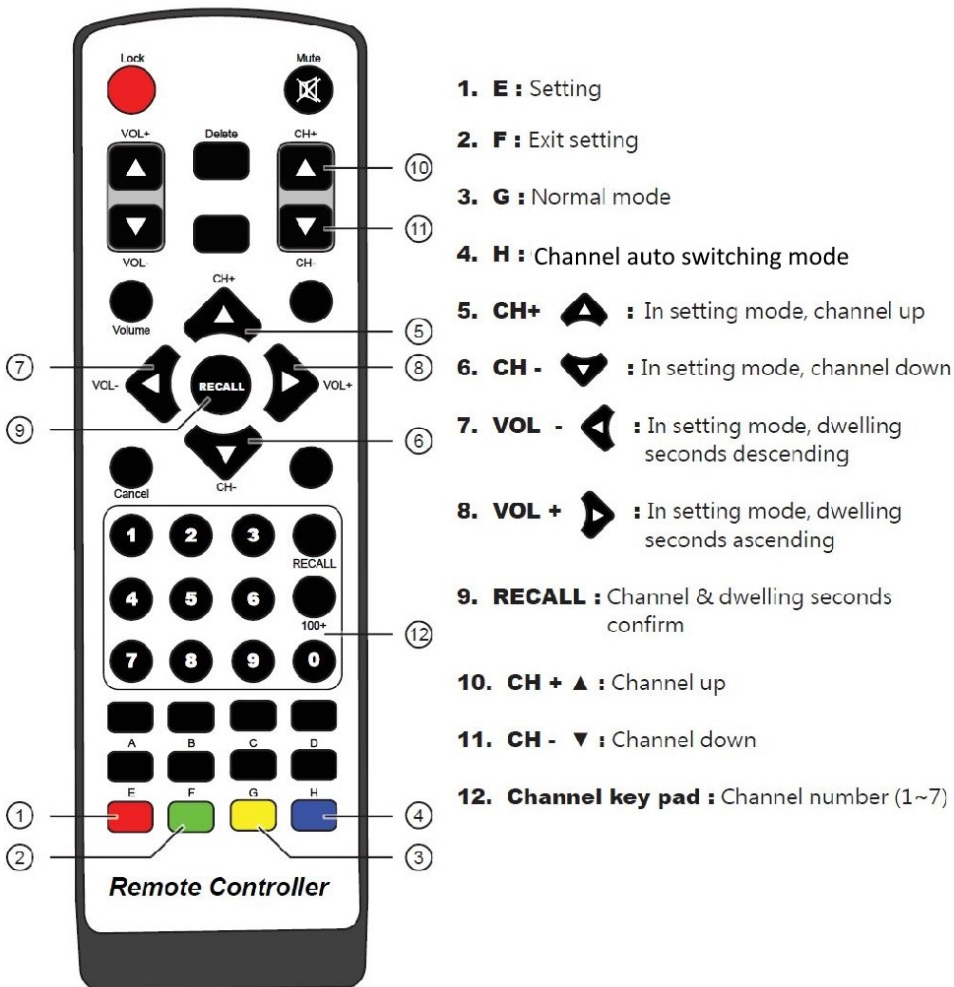

## Advanced receiver functions:

The receiver also has some advanced functions. The next couple of pages walk you through how to configure these advanced functions. You do not need to configure these settings for normal operation.

# USING YOUR SYSTEM: ADVANCED RECEIVER

## FUNCTIONS

The receiver has several advanced functions such as:

- Channel deleting; this allows you to setup the receiver to only display the channels you are actually using so you don't have to flip through un-used channels to get to your cameras.
- Auto circulate/auto channel switching; this mode automatically changes the receiver channel at a programmable interval so you can just sit back and relax as it automatically cycles through your cameras.

### Deleting channels

1. Press the "G" key to set the receiver to its default mode,
2. press "E" key to enter the programming mode, the display will start flashing,
3. use the up and down arrow keys to select the channel you wish to delete,
4. press the "RECALL" key,
5. use the left arrow key set the number on the screen to "00",
6. press the "RECALL" key again to confirm,
7. if you want to delete more channels, repeat steps 3 to 6,
8. once you are done deleting channels press the "F" to exit the programming mode.

### Re-adding deleted channels

1. Press the "G" key to set the receiver to its default mode,
2. Press the "E" key to enter the programming mode, the display will start flashing,
3. use the up and down arrows to find the channel you want to re-add,
4. press the "RECALL" key,
5. use the right arrow key to set the number on the screen to "05",
6. press the "RECALL" key again to confirm,

# **USING YOUR SYSTEM: ADVANCED RECEIVER**

## **FUNCTIONS**

7. if you want to re-add more channels repeat steps 3 to 6,
8. once you are done adding channels press "F" to exit the programming mode.

### **Configuring the auto circulate mode**

1. Press the "G" key to set the receiver to its default mode,
2. press "E" key to enter the programming mode, the display will start flashing,
3. use the up and down arrows to find the channel you want configure,
4. press the "RECALL" key,
5. use the right arrow key to set the number of seconds you want that channel to show for. If you set the display time to "00", that channel will not display in the auto circulate mode,
6. press the "RECALL" key again to confirm,
7. repeat steps 3 to 6 to configure every channel,
8. once you are done configuring channels, press "F" to exit the programming mode.

### **Starting/stopping auto circulate mode**

- Press the "H" key to start auto circulate mode,
- press the "G" key to stop auto circulate mode.

# USING YOUR SYSTEM: THE PTZ JOYSTICK

## CONTROLLER

The PTZ joystick controller is what you use to move your PTZ camera. It sends the control signal directly to the transmitter at the barn.

This section will explain the basic features of the PTZ joystick controller. The controller comes with its own detailed manual explaining all the advanced features.

### PTZ joystick controller layout diagram:

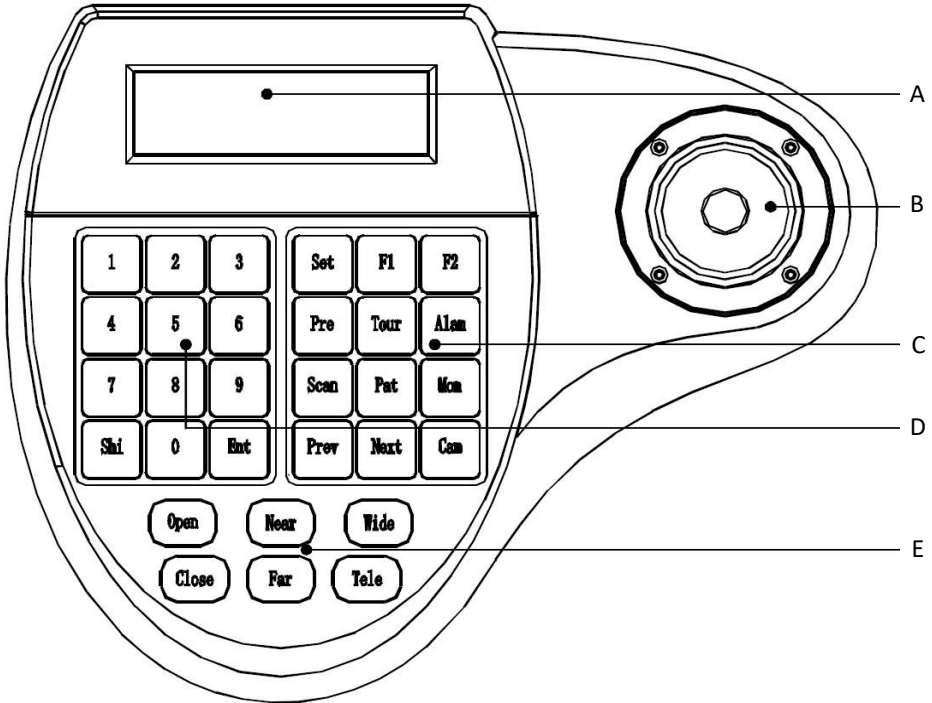

- A) Information display; this display tells you what camera you are currently set to. This screen also displays the parameters of the controller.
- B) Joystick; this is the main control interface for your camera. You can control the direction of your camera by moving it up and down, or left and right. You can also twist the joystick to zoom in and out.
- C) Function keys; this key pad contains the programming and preset keys.
- D) Number pad; this is used for changing the camera you are controlling, as well as entering numbers to run different pre-set functions.
- E) Lens control keys; these keys allow you to manual adjust the focus, zoom, and iris of the camera.

# USING YOUR SYSTEM: THE PTZ JOYSTICK

## CONTROLLER

When you first plug in the controller you will see a few things on the display:

- CamID; this tells you what camera you are currently controlling. By default this should be set to 001.
- MonID; this function is not used in the cowcam system so you don't have to worry about it. By default it should be set to 001.
- Protocol; this tells you what type of language the controller is using to communicate with the camera. You don't have to worry about this function, it should always stay set to Pelco D.
- Baudrate; this tells you how fast data flows from the controller to the camera. You do not have to worry about this function, it should always stay set to 2400.

To change what camera you are controlling, enter in the number you want to change to (ex: 001) followed by the "CAM" key. You can also change the camera ID using the "prev." and "next" keys.

If you're not sure what Cam ID your cameras are set to, you can find out by looking for the ID sticker on the camera itself.

You can also control several pre-set functions of the camera using the functions keys. For example, to run the windshield wiper on the 26X camera, enter in 63 on the keypad followed by the "pre" key.

Some other useful keys:

- Open/Close; these keys control the camera's iris, which controls the amount of light that gets into the camera. If you press open, the picture will get brighter, and if you press close, the picture will get darker. This function does not work on all cameras.
- Near/Far; these keys allow you to manually control the camera's focus. Press near to focus on something close, and far to focus on something farther away.
- Wide/Tele; this is another way to control the zoom. Wide zooms the camera out, and Tele zooms the camera in.
- Set; this key is for setting up pre-set locations. You can also access the controller's settings menu by holding this key for a few seconds.
- Tour/scan/pat; these keys are for running different types of automatic scans.

*(see page 32 for a list of useful pre-set commands )*

## USING YOUR SYSTEM: THE LCD CONTROLLER

The LCD controller is the same as the standard PTZ joystick controller except for the built in display. Please see the previous section for more information on using your controller.

When you first power up the LCD controller you see information on the display. To remove this information from the screen hold the “shi” key for 2 seconds.

### LCD controller layout:

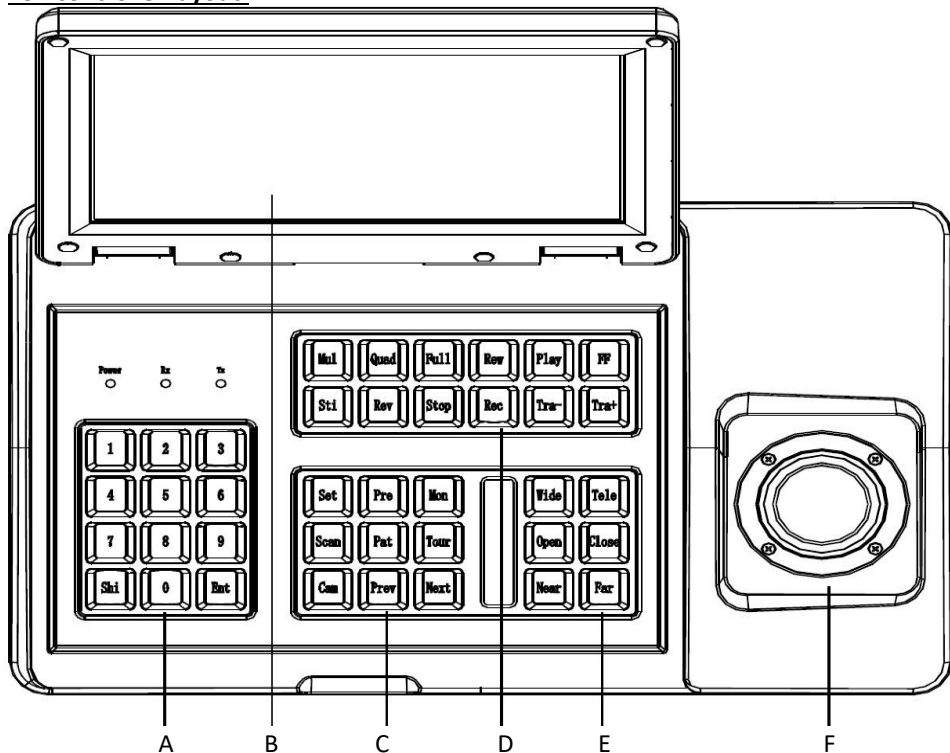

- A) Number pad; this is used for changing the camera you are controlling as well as entering numbers to run different pre-set functions.
- B) LCD display; this screen will display your camera. It also displays the parameters of the controller.
- C) Function keys; this key pad contains the programming and pre-set keys.
- D) DVR function keys; not used for cowcam system, ignore these.
- E) Lens control keys; these keys allow you to manually adjust the focus, zoom, and iris of the camera.
- F) Joystick; this is the main control interface for your camera. You can control the direction of your camera by moving it up and down, or left and right. You can also twist the joystick to zoom in and out.



# USING YOUR SYSTEM: THE DVR

This will be a basic overview of how to use your DVR. For detailed instructions please refer to the DVD manual included with the DVR.

## DVR layout diagram:

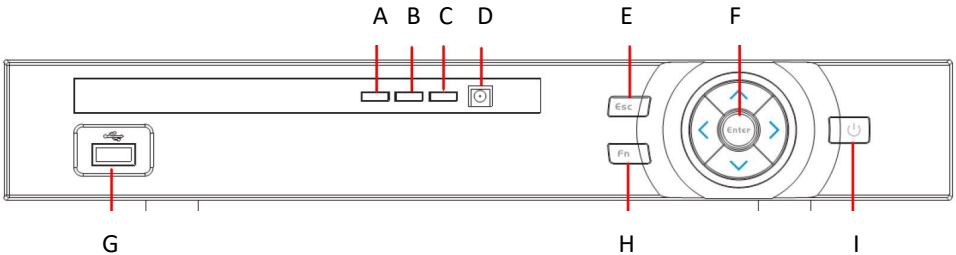

- A) Alarm indicator; this light will come on when an alarm is triggered.
- B) Network error indicator; this light will come on when there is a network issue.
- C) Hard disk error indicator; this light will come on if there is a hard disk problem.
- D) IR remote receiver; picks up signal from remote.
- E) Escape key; used to exit menus.
- F) Navigation keypad and enter key; used to navigate through menus.
- G) Front USB port; used to connect mouse or USB stick.
- H) Function key; used to access additional features in menus.
- I) Power button; can be used to power off unit.

## The basics:

- When you first power up your DVR you may see the “admin security” and “start-up wizard”, you can just click cancel for both.
- To log into the DVR, use the user name “user” and the password “8878”.
- To make your remote control work you may need to add it. To do this, point the remote at the DVR and press the add button at the top of the remote. A window will pop up on the screen. Enter the number 008 in the window and click ok. The remote is now ready to use.
- There are a couple of different camera viewing options available on the DVR. To change the view, right click on the screen with the mouse and choose either view 1 to view a single camera or view 4 to see 4 cameras at the same time in a split screen configuration.
- You can also control your PTZ cameras through the DVR by right clicking on the camera you want to control and selecting PTZ. This will bring up a small control panel you can use to move the camera.

# **USING YOUR SYSTEM: THE DVR**

## **Viewing recorded footage:**

- Right click on the screen and click “search” from the drop down menu. You may be asked to log in at this point.
- You will see a calendar on the right side of the screen, use this to select the day from which you wish to view footage.
- Once you select the date you will see the video clips that are available to view on the timeline at the bottom of the screen. To watch just click on the timeline.

## **Saving recorded footage:**

- Plug a USB stick into the DVR.
- Go to the same menu you would use to view the footage and select where you would like the saved footage to start on the time line.
- Click the video clip icon at bottom right corner of the screen.
- Then click the save icon at the bottom right corner.
- Select the video clips you want to save, select the device you want to save them to and click backup.
- The video will then take a few minutes to record to the USB stick.

## **Viewing the saved footage on a pc:**

- Plug the USB stick into your pc and open it up.
- Run the application on the USB stick called “play”.
- Click the small arrow icon on the far left side of the tool bar and browse through your files until you get to the USB stick.
- Click the .DAV files that are on the USB stick and they will start playing.

## **Viewing the DVR on your smart phone:**

The first time you view your camera from your smartphone or tablet you will have to configure the DVR as well as your phone. After the first time you set everything up, viewing the camera will be fairly simple.

### **Part 1— Setting up P2P on the DVR:**

This part of the setup should already be done when you receive the DVR, but just in case you have to reset your DVR or it has not been configured already, follow these steps first. Otherwise skip forward to the Smartphone configuration section.

- Right click on the screen of the DVR and select main menu from the drop down menu. At this point in time you may need to log in.
- Click network under the setting section of the menu, go to the TCP/IP section of the menu (if not there already), and change the mode to DHCP. Click apply.
- Now go to the P2P section of the menu and click enable (so the box has a check mark) then click save.

# USING YOUR SYSTEM: THE DVR

## \*Part 2—Configuring the app on your smart phone:

- Right click on the screen of the DVR and select main menu from the drop down menu. At this point in time you may need to log in.
- Click network under the setting section of the menu.
- Go to the P2P section of the menu. You will see the QR codes. These will be used later, leave this screen open.

## If you have an Iphone:

- Download an app called IDMSS LITE then open the app.
- Push the lines icon in the upper left. This is your menu. Push the device manager menu option to open.
- Push the + icon on upper right for a new connection.
- Choose P2P.
- Hit the QR scan at the top.
- Take a picture of the QR scan code on your monitor.
- Give the connection a name.
- Enter your user name and password for the DVR.
- Click live preview at the bottom to see your cameras.

## If you have an Android phone:

- Download an App called GDMSS LITE and launch it.
- Click the camera icon in the upper right corner of the screen.
- Click the plus button to make a new connection.
- Click P2P, then click the QR scan code in the SN: section.
- Your camera will open. Take a picture of the QR scan code on your monitor.
- Enter a name for the device such as “cowcam”.
- Enter your user name and password for the DVR.
- Click live preview at the bottom to see your cameras.

Now whenever you want to view your cameras, just open up the app on your phone and select your device from the same menu you used to configure the device. It will appear in a list. Select it, then click “start live preview”.

If you were not able to make this method work you may need to setup what is called port forwarding. Port forwarding requires an advanced knowledge of networking and is usually done remotely by us. If you think you may need to use port forwarding, please call our shop and request to talk to a tech for help with port forwarding.

## USING YOUR SYSTEM: THE OUTDOOR RECEIVER

Changing the channel on the outdoor receiver is done with the joystick controller. The outdoor receiver changes its channel based on the Cam ID on the controller. For example, if you enter in "2" then "CAM" on the joystick controller to control camera 2 then move the joystick, the receiver will automatically change itself to channel 2. The channel the receiver changes to will always be the same as the Cam ID (up to #7).

The outdoor receiver does not have any advanced functions like the standard receiver.

When using the outdoor receiver with a DVR, and you wish to change the channel of the receiver, you must first click on the camera box that corresponds to the camera you wish to view (even though they all show the same picture), then bring up the PTZ menu and press one of the arrow buttons. The receiver will now change to the correct camera.

## HOW TO CHANGE THE TRANSMITTER CHANNEL

Sometimes it is necessary to change the channel on your transmitter. To do this, remove the cover of the transmitter and adjust the channel using the channel buttons.

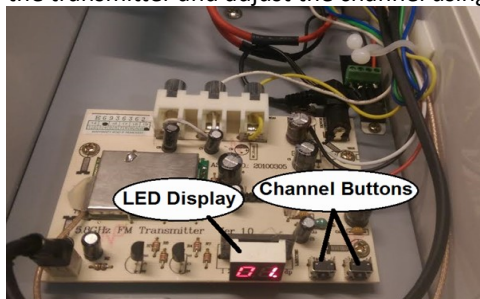

## HOW TO ADJUST THE AUDIO MOD

To adjust the volume level of the audio mod, remove the front cover of the audio mod and turn the adjustment knob inside.



# **PTZ CAMERA FEATURES**

The PTZ cameras have many special features. We have compiled a list of some of the most commonly used ones. For a full list of all the cameras' advanced features, please refer to the manual that comes with the camera itself.

## **Controller commands :**

- 63 + PRE; this will run the windshield wiper on the 26X cameras.
- 95 + PRE; this will open the main menu on all PTZ cameras.
- SET + (any #) + PRE; this will save a pre-set location.
- (any #) + PRE; this will call a pre-set location.
- (any #) +Tour; this will run a tour.
- 94+PRE; this will restart 26X cameras.
- 34+PRE; this will restart 10X cameras.

## **Pre-set locations:**

A Pre-set location is a viewing location that is stored in the camera memory and can be called up later.

## **Tours:**

A tour is a pattern of several pre-set locations that the camera can be configured to automatically cycle through (*See cameras' manual for setup instructions* ).

## **Optical zoom:**

Optical zoom is the amount of mechanical zoom range on the cameras lens.

## **Digital zoom:**

The 26X cameras have extra zoom capability called digital zoom. This extra zoom is achieved by stretching the picture. This works in much the same way as zooming into a picture on your computer. You will notice that the picture is lower quality when using the digital zoom to its full extent.

## **Day and night mode:**

All night vision cameras have a day and a night mode. In the day mode you will see full color. In the night mode you will see only black and white and the camera will turn on its infrared lights.

## **PTZ:**

PTZ stands for Pan, Tilt, and Zoom. Panning is the left and right movement of the camera head. Tilting is the up and down movement of the camera head. Zooming is the ability to change the lens angle of the camera from zoomed in (telephoto) to zoomed out (wide angle).

## **Heating, Cooling, and Defogging:**

The PTZ cameras contain heaters and fans to control the temperature of the camera to allow it to remain cool in hot weather and to stop it from freezing up in very cold weather (*See cameras manual for more info*).

# **TROUBLESHOOTING: STATIC OR POOR PICTURE**

The 2 main causes of a poor picture are interference or low signal strength.

## **Eliminating interference:**

- Unplug or turn off any other wireless/RF devices you have in your home or in the farm yard, one at a time. This includes things like Wi-Fi routers, microwave ovens, cordless phones, game consoles, cell boosters, cell phones etc.
- If you can not find the source of the interference, you may need change the channel on your transmitter and receiver until you find a channel that is free of interference.
- If you do have something that is causing interference you will have to change the channel of that device, or the cowcam.

## **Getting a stronger signal:**

- The most important thing when getting a strong signal is having a clear line-of-sight from the transmitter to the receiver with as little obstructions as possible.
- Some things that will weaken your signal are trees, metal structures, land formations, brick, stucco siding, foil insulation, Low-E windows, metal siding, hay bales, vehicles, and going through too many walls.
- There are a few things you can do to help this signal like repositioning your receiver, removing obstructions from your line-of-sight, mounting an external antenna, or using an outdoor receiver kit.
- The best position for your receiver is against the wall that faces your camera location. You should have the receiver on a high surface like the top of a TV stand or on a shelf, not tucked away inside a TV cabinet. We recommend at least 6' above ground level if possible.
- You always want your antennas to be in a vertical position, this is important to maintain the correct signal polarization.
- When mounting an external antenna on the house we don't recommend using more than 20 feet of antenna cable. This is because even though the high gain antenna can pick up more signal than the regular antenna, using a long cable will cause signal loss which will render the high gain antenna useless.

## **TROUBLESHOOTING: STATIC OR POOR PICTURE**

- If you are using high gain antennas at the house or the barn, you must make sure they are precisely aimed at each other to ensure the best signal possible.
- To get a better signal you can also move the transmitter to a better location using a longer camera cable. The longest cable length we recommend is 115 feet.
- You can also relocate the receiver within your house using a longer RCA cable, or an extender kit. This will allow you to place the receiver at a location that gets a better signal without having to move the TV.

## **TROUBLESHOOTING: NO PTZ CONTROL**

- A very common cause for losing control of the camera is having the controller set to the wrong camera ID. This can be easily corrected by changing the controller back by entering the correct camera ID (ex: 001) followed by the “CAM” key.
- If you are not sure what your camera ID is, there are a few ways to find it. The camera ID is usually displayed in the top corner of the screen on your TV (ex: 001). There is also a sticker on the camera that indicates the camera ID. You can also find the camera ID by restarting the camera and watching the TV screen while the camera does its start up routine.
- If you are sure you have the correct camera ID and you still don't have control, check that the antenna on the controller is screwed on tightly, pointed up, and says either 433MHz or “for controller” on it.
- To determine if you are just getting poor signal range, take your controller to the camera location and plug it in, you don't need to bring the receiver. Try to control the camera from this location and watch the camera itself to see if it moves. If it does move, you have a range issue which is usually related to the antenna. Check the antenna on the transmitter to ensure it is on the correct connector, tight, and pointed downward.
- If the camera still does not move while you are close to it with the controller, you may have an issue with the controller, camera, transmitter or a cable. At this point you should follow the flow chart at the back of this book for a step-by-step guide for finding the root of the issue, or give us a call for help.

## **TROUBLESHOOTING: CAMERA IS “DEAD SPINNING”**

- Dead spinning is when the camera rotates continually on its own and you are unable to make it stop. The two major causes for this are poor signal and improper joystick calibration.
- To see if your joystick is out of calibration, watch the screen of the joystick controller, is there an arrow showing on the display even though your not touching the joystick? If there is, this means you need to re-calibrate the joystick. To re-calibrate, just unplug power from the controller, and plug it back in being careful to not touch the joystick. Once it's powered back on, move the joystick and watch to see if the arrow on the screen goes away once you release it. If it does, the issue will be resolved. It's now just a matter of setting the controller to the correct camera ID and moving the joystick to stop the dead spin.
- If re-calibrating your joystick does not help, you more than likely have a signal issue. If this is the case, please refer to the previous section, or follow the troubleshooting flowcharts at the back of the book.

## **TROUBLESHOOTING: OTHER COMMON PROBLEMS AND SOLUTIONS**

- Hard reset: Many issues can be fixed by simply unplugging everything at the house and barn, waiting a few minutes, then plug it all back in.
- TV says no signal: Check if the TV is set to the correct input setting.
- Picture is in black and white during the day: Make sure the TV is set to AV or composite not component.
- Camera changes to black and white mode during the day: If the area you are using the camera in is to dark the camera may think it's night mode and change to black and white. To fix this you can change the day/night sensitivity settings in the camera menu. Please refer to the manual that came with the camera to see how to do this.
- Getting static or crackling noise through TV speakers even though you don't have an audio mod: Disconnect the RCA cables from red and white audio connectors on the receiver box.
- Sound only comes through one of your two speakers: If you have a RCA cable with only 2 connectors you will have to switch it out with a cable that has all 3, or you can use an RCA splitter at the TV to feed the audio signal into both audio ports of the TV.



# TROUBLESHOOTING FLOW CHART: NO PTZ CONTROL

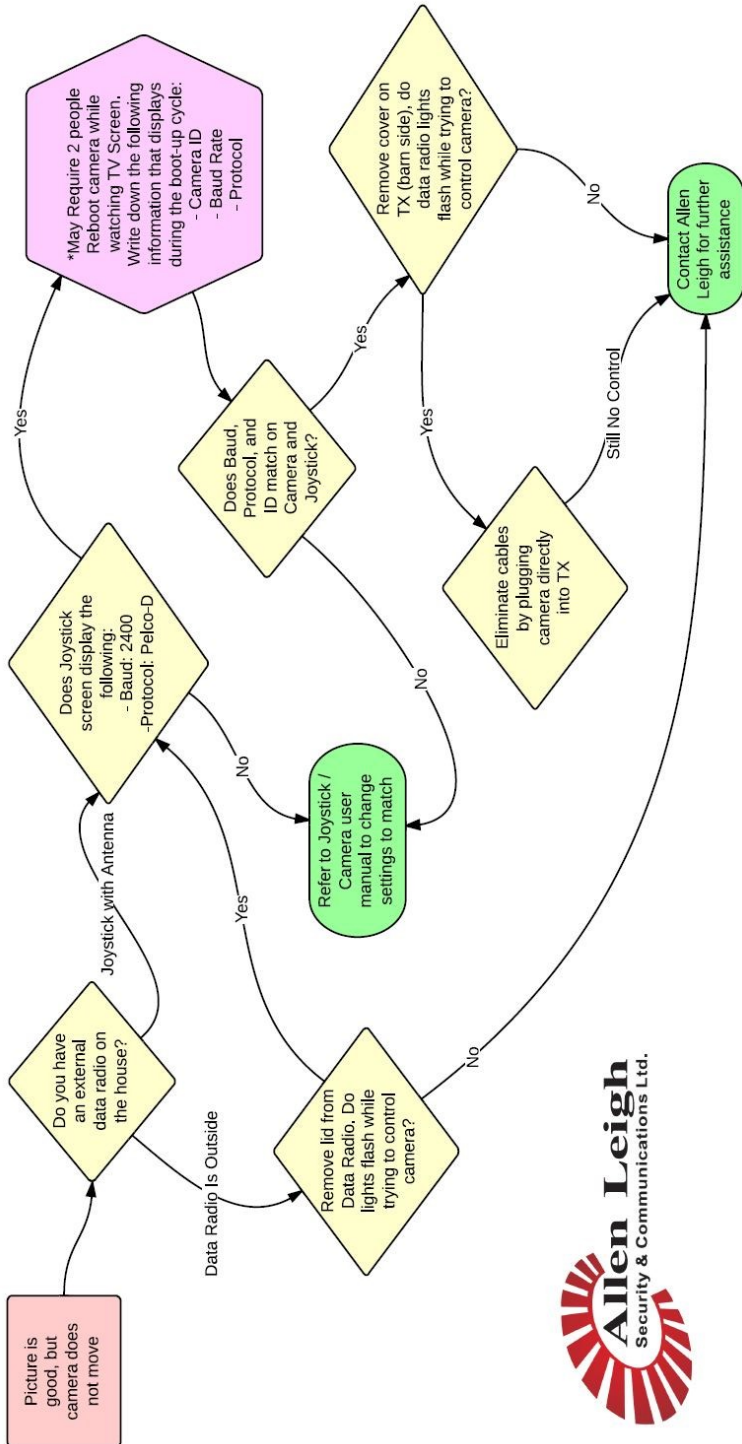

# TROUBLESHOOTING FLOW CHART: NO PICTURE

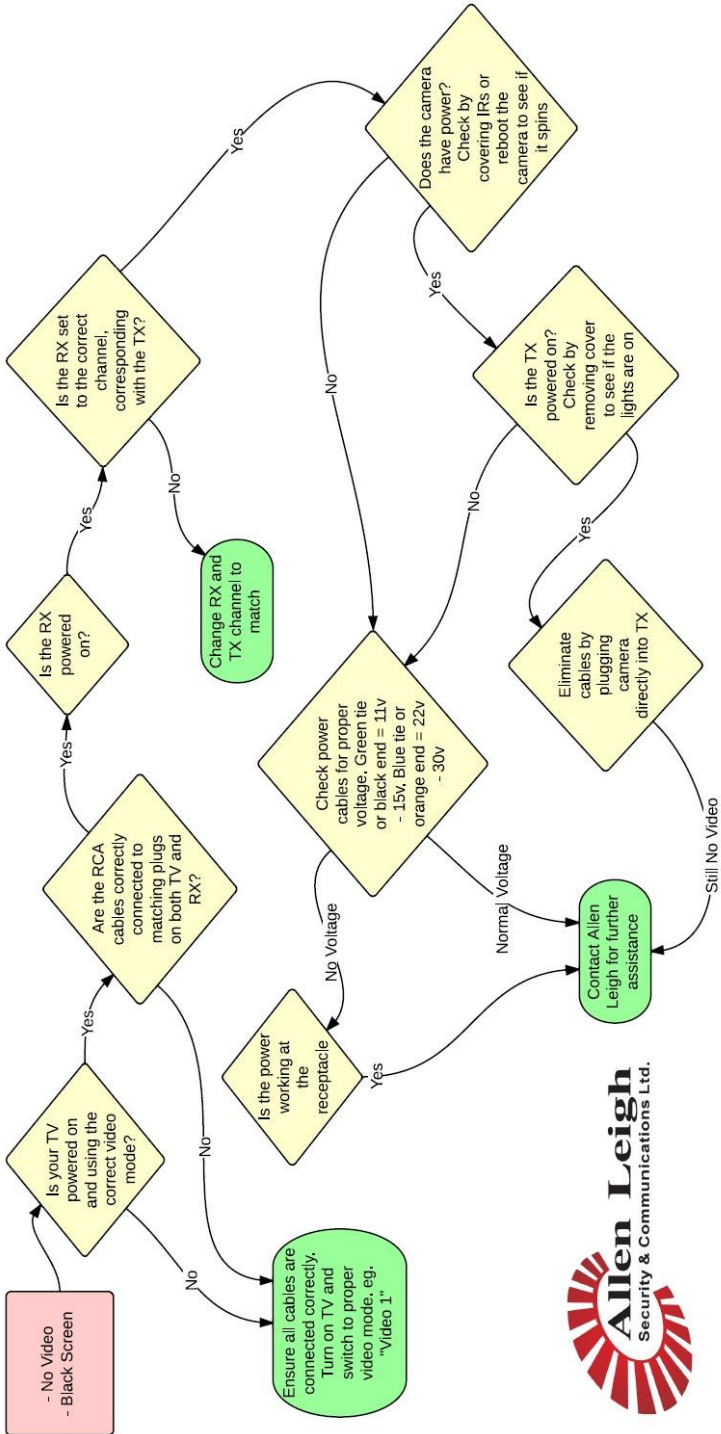

# TROUBLESHOOTING FLOW: POOR PICTURE

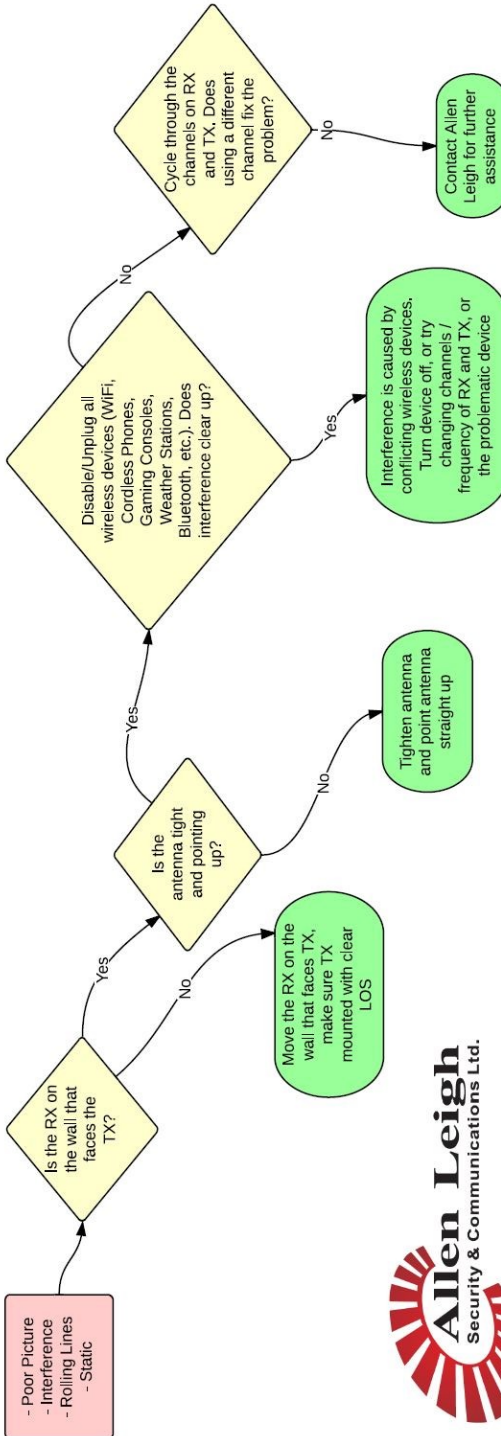

## WARRANTY COVERAGE

Allen Leigh Security is proud to offer a one year warranty on our livestock monitoring systems which covers any manufacture defects . The warranty does **not** cover the following:

- Damage caused by acts of nature such as tornados, hail, lightning strikes, fallen trees, excessive amounts of rain or snow, flooding, fire etc.
- Damage caused by electrical problems such as voltage spikes, surges, poor quality power, improper grounding, static discharge, or black outs.
- Damage caused by improper installation, or use of product.
- Damage caused by shipping companies, or as a result of inadequate packaging material from customer.
- Damage caused by full submersion in liquids of any sorts, accidental or otherwise.
- Abuse or mechanical damage resulting in system failure, such as dropping or hitting equipment.

If there is a requirement to return your system to ALSC, please contact us to receive an RMA#. Write your RMA# on the package being shipped, and ensure that it is shipped properly.

## **LOANER PROGRAM**

We understand that once you have used a cowcam livestock monitoring system it's hard to live without, that's why we offer a loaner equipment program. In the event that you need to send in your system for repair or maintenance you can be supplied with a loaner to keep you up and running.

- We require a valid credit card number to be on file for the duration of the loaner use.
- A damage deposit of 33% of the retail value of equivalent new equipment will be held until all equipment is returned and confirmed to be in the same condition as it was when it left our shop. If any damage to loaner equipment is found, the cost to repair said damages will be subtracted from the damage deposit. The full retail value of any loaner equipment that is not returned will also be subtracted from the damage deposit.
- If you are not under warranty, a monthly rental fee will be charged based on the type of equipment borrowed.

### **Loaner rental rates:**

- 26X camera: \$150/month.
- 10X camera: \$90/month.
- PTZ joystick controller: \$60/month.
- DVR: \$60/month.
- Transmitter: \$100/month.
- Receiver \$30/month.
- Other: based on product value.







A Brand of



"Trusted Quality, Trusted Support, Trusted Service!"

and



Allen Leigh Security and Communications Ltd.  
545 Assiniboine Ave  
Brandon, MB R7A 0G3

Tel: 204-728-8878  
Toll Free: 1-866-289-8164  
Fax: 204-725-2234  
Email: [info@allenleigh.ca](mailto:info@allenleigh.ca)  
Web: [www.allenleigh.ca](http://www.allenleigh.ca)

Facebook: [AllenLeighSC](#)  
Twitter: [@AllenLeighSC](#)  
YouTube: [Allen Leigh Security & Communications](#)